

TWG - MECHANICAL TORQUE MULTIPLIERS



Torque capacities up to 10000 Nm

Lightweight aluminium housing

Supplied complete with reaction arm

The Hi-Force TWG range of mechanical torque multipliers offers output torque capacities from 50 to 10000 Nm with gearbox multiplication ratios from 1:4 to 1:28.5. Available in a choice of 6 models, each fitted with a high performance aluminium housing, all models are ideal for use in bolting applications in many industries including oil & gas, construction, railways, ship building, machinery & plant engineering and heavy vehicle workshops.

All models are supplied with an offset reaction arm and models TWG40, TWG60 and TWG100 are additionally fitted with an anti-wind up ratchet and non-destructive overload safety mechanism for enhanced gear protection. Hi-Force manual torque wrenches recommended for use with TWG torque multipliers are detailed on page 68 of this catalogue.

- >> Single stage planetary gear in models up to 2800 Nm
- >> Compact two stage planetary gear in models up to 10000 Nm
- >> Output square drives of 3/4", 1" and 1 1/2"

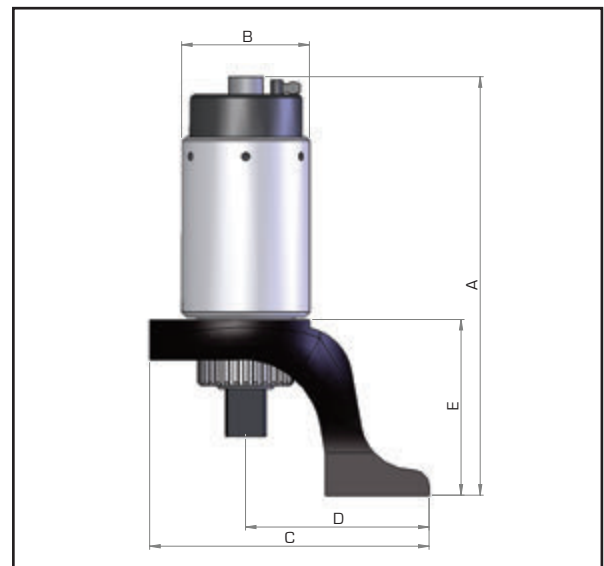

Model number	Torque capacity		Gearbox ratio	Input square drive	Output square drive	Recom. torque wrench	Weight kg	Dimensions in mm				
	Nm	lbf.ft						A	B	C	D	E
TWG13	1300	950	1:5	1/2"	3/4"	TWM300	1.3	133	80	124	96	98
TWG20	2000	1500	1:4	3/4"	1"	TWM550	1.8	131	88	190	150	80
TWG28	2800	2050	1:5.5	3/4"	1"	TWM550	2.4	146	106	156	159	83
TWG40	4000	2930	1:16	1/2"	1"	TWM300	4.2	227	88	175	135	110
TWG60	6000	4400	1:18	3/4"	1 1/2"	TWM400	6.6	256	102	240	190	145
TWG100	10000	7330	1:28.5	3/4"	1 1/2"	TWM400	10.9	292	142	267	215	163